

# Control valve(3/2 way)

## ZM3 Series

### Specification

Model	ZM3R	ZM3J	ZM3P
Fluid	Air( to be filtered by 40um filter element)		
Acting	External control direct acting type		
Port size ①	1/8"		
Valid area of section	6.0mm <sup>2</sup> (Cv=0.34)		
Valve type	3 port 2 position		
Lubrication ②	Not required		
Operating pressure	-0.1~1.0MPa(-15~145psi)		
Proof pressure	1.5MPa(215psi)		
Temperature ℃	-20~70		
Material of body	Aluminum alloy		

- ① G thread and PT thread are available;  
 ② It can not stop in the midway of lubricating.  
 Lubricants like ISO VG32 or equivalent are recommended;

### Ordering code

**ZM3 R - 06 - W - G**

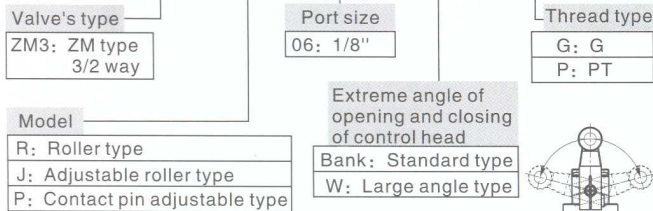

### Flow chart

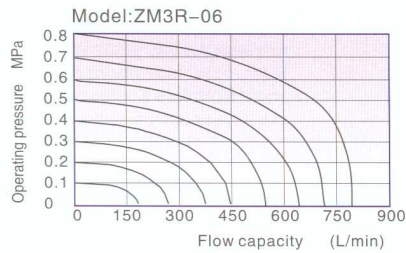

### Inner structure

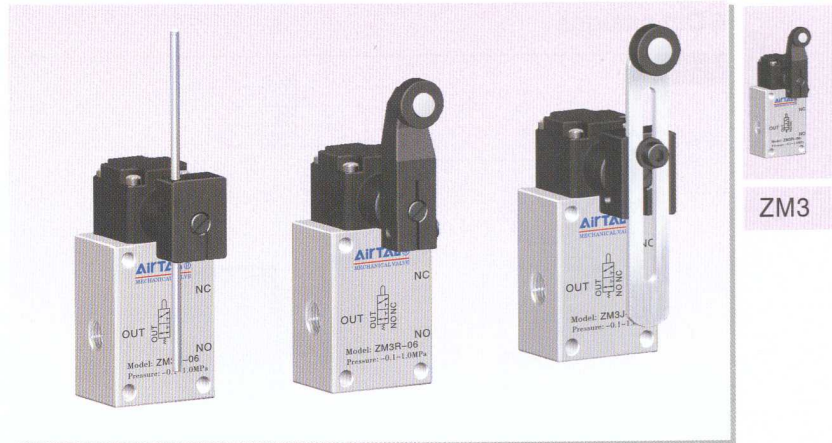
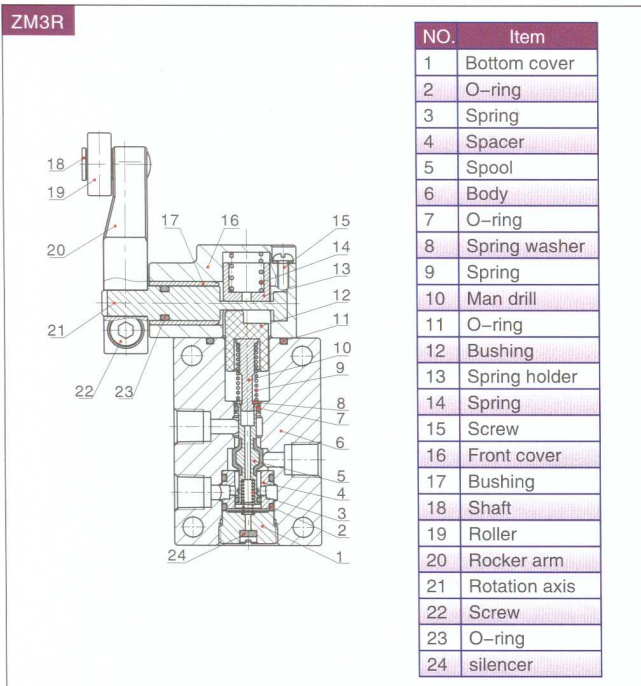

### Symbol



### Product feature

1. The activity direction could be changed

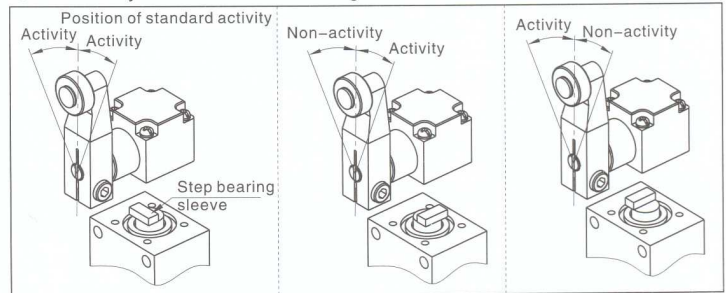

2. The rolling wheel could be installed at the inside of leverage

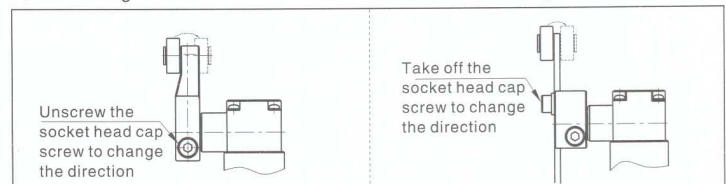

3. Installation position of leverage could be changed 4. Direction of head part could be changed

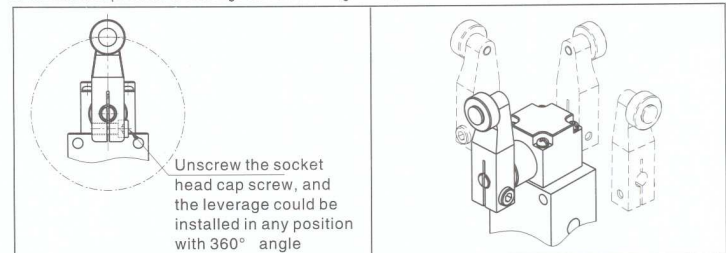

5. Length of contact pin could be changed

